

Mitel 6865i SIP Phone

41-001506-00 REV03

INSTALLATION GUIDE

NOTICE

The information contained in this document is believed to be accurate in all respects but is not warranted by Mitel Networks™ Corporation (MITEL®). The information is subject to change without notice and should not be construed in any way as a commitment by Mitel or any of its affiliates or subsidiaries. Mitel and its affiliates and subsidiaries assume no responsibility for any errors or omissions in this document. Revisions of this document or new editions of it may be issued to incorporate such changes.

No part of this document can be reproduced or transmitted in any form or by any means - electronic or mechanical - for any purpose without written permission from Mitel Networks Corporation.

Trademarks

The trademarks, service marks, logos and graphics (collectively "Trademarks") appearing on Mitel's Internet sites or in its publications are registered and unregistered trademarks of Mitel Networks Corporation (MNC) or its subsidiaries (collectively "Mitel") or others. Use of the Trademarks is prohibited without the express consent from Mitel. Please contact our legal department at legal@mitel.com for additional information. For a list of the worldwide Mitel Networks Corporation registered trademarks, please refer to the website: <http://www.mitel.com/trademarks>.

Mitel's Power Over Ethernet (PoE) Powered Device (PD) products are covered by one or more of the U.S. patents (and any foreign patent counterparts thereto) identified at Mitel's website: www.mitel.com/patents. For more information on the PD patents that are licensed, please refer to www.cmspatents.com.

Mitel 6865i SIP Phone Installation Guide

41-001506-00 REV03 - February 2016

®,™ Trademark of Mitel Networks Corporation
© Copyright 2016, Mitel Networks Corporation
All rights reserved

SOFTWARE LICENSE AGREEMENT

Mitel, hereinafter known as "Seller", grants to Customer a personal, worldwide, non-transferable, non-sublicenseable and non-exclusive, restricted use license to use Software in object form solely with the Equipment for which the Software was intended. This Product may integrate programs, licensed to Mitel by third party Suppliers, for distribution under the terms of this agreement. These programs are confidential and proprietary, and are protected as such by copyright law as unpublished works and by international treaties to the fullest extent under the applicable law of the jurisdiction of the Customer. In addition, these confidential and proprietary programs are works conforming to the requirements of Section 401 of title 17 of the United States Code. Customer shall not disclose to any third party such confidential and proprietary programs and information and shall not export licensed Software to any country except in accordance with United States Export laws and restrictions.

Customer agrees to not reverse engineer, decompile, disassemble or display Software furnished in object code form. Customer shall not modify, copy, reproduce, distribute, transcribe, translate or reduce to electronic medium or machine readable form or language, derive source code without the express written consent of the Seller and its Suppliers, or disseminate or otherwise disclose the Software to third parties. All Software furnished hereunder (whether or not part of firmware), including all copies thereof, are and shall remain the property of Seller and its Suppliers and are subject to the terms and conditions of this agreement. All rights reserved.

Customer's use of this software shall be deemed to reflect Customer's agreement to abide by the terms and conditions contained herein. Removal or modification of trademarks, copyright notices, logos, etc., or the use of Software on any Equipment other than that for which it is intended, or any other material breach of this Agreement, shall automatically terminate this license. If this Agreement is terminated for breach, Customer shall immediately discontinue use and destroy or return to Seller all licensed software and other confidential or proprietary information of Seller. In no event shall Seller or its suppliers or licensors be liable for any damages whatsoever (including without limitation, damages for loss of business profits, business interruption, loss of business information, other pecuniary loss, or consequential damages) arising out of the use of or inability to use the software, even if Seller has been advised of the possibility of such damages.

- Software License Agreement ii
- Welcome 1
 - Phone Features1
 - Requirements2
 - About This Guide2
- Phone Parts 3
 - Additional Accessories (Not Included)3
- IP Phone Keys 4
 - Key Panel4
 - Key Description5
- Installation and Setup 7
 - Direct or Shared Network Connection7
 - Direct Network Connection7
 - Shared Network Connection8
 - Connecting to the Network and to Power8
 - Power Adapter8
 - Inline Power9
 - Connecting a Handset or Headset10
 - Handset10
 - Headset (Optional)10
 - Installation11
 - Desk Installation11
 - Wall Installation12
 - Inserting the Key Card12
 - Accessing Your Options via the Phone UI13
 - Accessing Your Options via the Mitel Web UI13
- Troubleshooting Solutions 15
 - Why is the light not coming on with a new voice mail message?15
 - Why is my handset not working?15
 - Why is my display blank?15
 - Why does the telephone wobble?15
 - What is a programmable key?15
- Limited Warranty..... 16
 - Exclusions16
 - Warranty Repair Services16
 - After Warranty Service16

Limited Warranty (Australia Only) 17

 Repair Notice 17

 Exclusions 17

 Warranty Repair Services 18

 After Warranty Service 18

WELCOME

Congratulations on your purchase of the Mitel Model 6865i SIP Phone! The Mitel 6865i offers exceptional flexibility in a true enterprise grade SIP desktop phone that has Dual Gigabit Ethernet ports and features a large 3.4" 128x48 pixel LCD display. Its soft white backlighting and large fonts making the screen easy to read in any lighting conditions. With its 8 programmable keys, XML capabilities, native DHSG/EHS headset support, a true HD handset and a speakerphone that delivers remarkable wideband HD audio quality, the Mitel 6865i SIP phone is ideally suited for the small to large business market that needs Gigabit throughput for PC connectivity.

PHONE FEATURES

- LCD screen with backlight
- Built-in-two-port, 10/100/1000 Gigabit Ethernet switch - lets you share a connection with your computer
- 8 programmable top keys
- Press-and-hold speeddial key configuration feature
- Supports 2 hard line keys with LEDs (additional line keys configurable via programmable keys)
- Wideband handset
- Wideband, full-duplex speakerphone for handsfree calls
- Headset mode support
- AC power adapter (sold separately)
- Enhanced busy lamp fields*
- Set paging*

*Availability of feature dependent on your phone system or service provider.

REQUIREMENTS

- SIP-based IP PBX system or network installed and running with a SIP account created for the 6865i phone.
- Access to a Trivial File Transfer Protocol (TFTP), File Transfer Protocol (FTP), Hypertext Transfer Protocol (HTTP) server, or Hyper Text Transfer Protocol over Secure Sockets Layer (SSL) (HTTPS).
- Ethernet/Fast Ethernet LAN (10/100 Mbps) (Gigabit Ethernet LAN [1000 Mbps] recommended).
- Category 5/5e straight-through cabling (Category 6 straight-through cabling required for optimum Gigabit Ethernet performance).
- Power source:
 - For Ethernet networks that supply inline power to the phone (IEEE 802.3af) use an Ethernet cable to connect from the phone directly to the network for power (no 48VAC power adapter required if using Power-over-Ethernet [PoE]).
 - For Ethernet networks that DO NOT supply power to the phone:
 - Use only the GlobTek Inc. Limited Power Source [LPS] adapter model no. GT-41080-1848 (sold separately) to connect from the DC power port on the phone to a power source
or
 - Use a PoE power injector or a PoE switch.

ABOUT THIS GUIDE

This manual describes how to physically set up your new 6865i SIP Phone. Not all features listed are available by default and some may depend on your phone system or service provider. Contact your system administrator if you have any questions on what features and services are available to you on your system.

PHONE PARTS

When you unpack your phone, you should ensure that you have all of the following items. If any part is missing, contact the supplier of your phone.

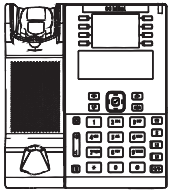

Telephone



Handset



Handset Cord

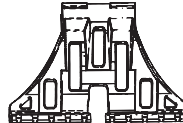

Two-Angle Stand

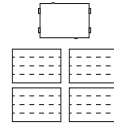

Key Cards and
Plastic Cover



Regulatory/
Safety Insert

ADDITIONAL ACCESSORIES (NOT INCLUDED)

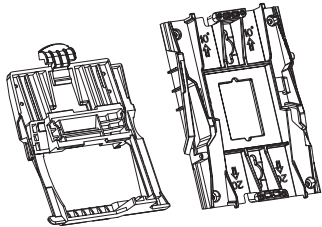

Wall Mount Kit

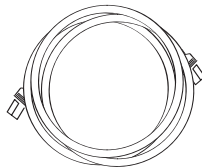

Ethernet Cable(s)

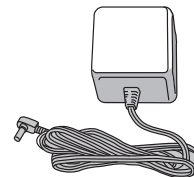

Power Adapter

IP PHONE KEYS



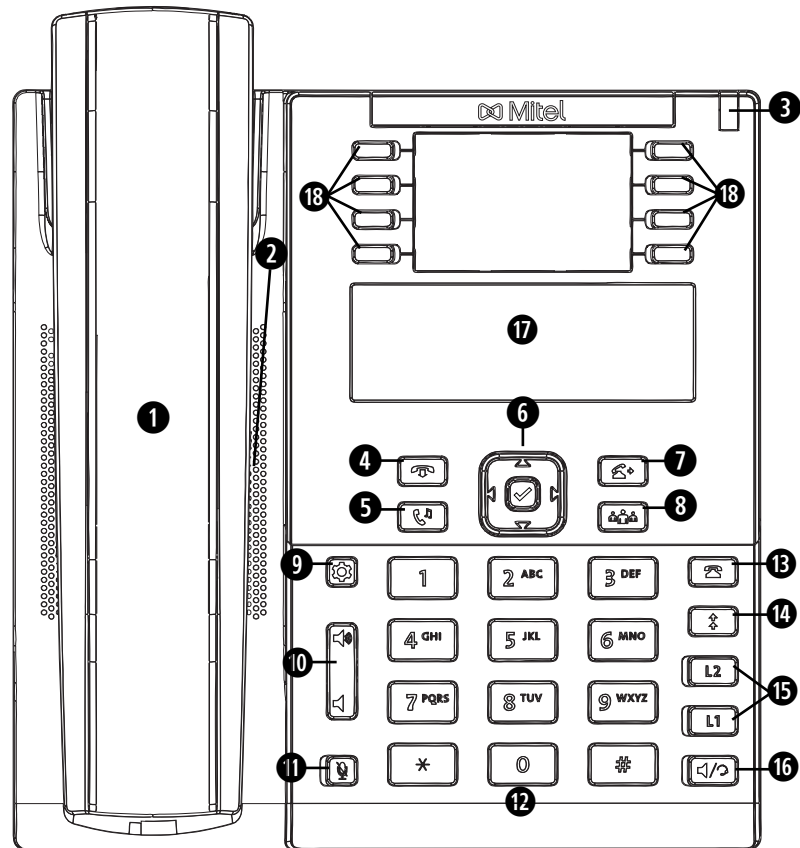







KEY PANEL









1	6865i Handset	10	Volume Control
2	High Quality Speakerphone	11	Mute Key
3	Message Waiting Lamp	12	Keypad
4	Goodbye Key	13	Callers List Key
5	Hold Key	14	Redial Key
6	Navigation/Select Keys	15	Line/Call Appearance Keys
7	Transfer Key	16	Speaker/Headset Key
8	Conference Key	17	LCD Screen
9	Options Key	18	Programmable Keys

KEY DESCRIPTION

The following table describes the keys on the 6865i SIP Phone.

KEY	DESCRIPTION
	Goodbye Key - Ends an active call. The Goodbye key also exits an open list, such as the Options List, without saving changes.
	Hold Key - Places an active call on hold. To retrieve a held call, press the call appearance button beside the light that is flashing.
	Navigation/Select Keys - Pressing the UP and DOWN keys lets you view different status and text messages on the LCD display (if there is more than 1 line of status/text messages). These buttons also let you scroll through menu selections, such as the Options List. Pressing the LEFT and RIGHT keys lets you view the different line/call appearances. While in the Options List, these keys allow you to exit or enter the current option. When you are editing entries on the display, pressing the LEFT key erases the character on the left; pressing the RIGHT key sets the option. Alternatively, pressing the center Select key sets the option as well on specific screens.
	Transfer Key - Transfers the active call to another number.
	Conference Key - Begins a conference call with the active call.
	Options Key - Accesses services and options to customize your phone. Your System Administrator may have already customized some of your settings. Check with your System Administrator before changing the administrator-only options.
	Volume Controls - Adjusts the volume for the handset, ringer, and handsfree speaker.
	Mute Key - Mutes the microphone so that your caller cannot hear you (the light indicator flashes when the microphone is on mute).
	Callers List Key - Accesses a list of the last 200 calls received.
	Redial Key - Accesses a list of the last 100 previously dialed numbers. Pressing the Redial key twice redials the last dialed number.

KEY	DESCRIPTION
	Line/Call Appearance Keys - Connects you to a line or call. The Mitel 6865i IP Phone supports two line keys, each with LED indicator lights.
	
	Speaker/Headset Key - Transfers the active call to the speaker or headset, allowing handsfree use of the phone.
   	Programmable Keys - When programmed, allows you to easily perform up to 8 specific functions (e.g. Services, Directory, Callers List, Intercom, etc...) and access enhanced services provided by third parties (e.g. XML applications).

INSTALLATION AND SETUP

The 6865i SIP Phone can be setup to share a network connection with another network device. Power can be provided by the power adapter (sold separately), by an 802.3af compliant network power source, or with a PoE inline power injector.



Notes:

1. This product is designed for indoor use only and for ambient temperatures at or below 40° C (104° F).
2. The phone must be connected only to indoor routed PoE or Ethernet wiring.

DIRECT OR SHARED NETWORK CONNECTION

The phone can be set up as a direct network connection to the Ethernet wall jack or as a shared network connection as a pass-through if connecting the phone to a computer or another network device.

DIRECT NETWORK CONNECTION

Located on the back of the phone are two fully switched 10/100/1000 Mbps Ethernet cable ports. The port marked with  is used to connect the phone to the network, as well as provide power to your phone (if required). See [“Connecting to the Network and to Power”](#) on [page 8](#) for more information.

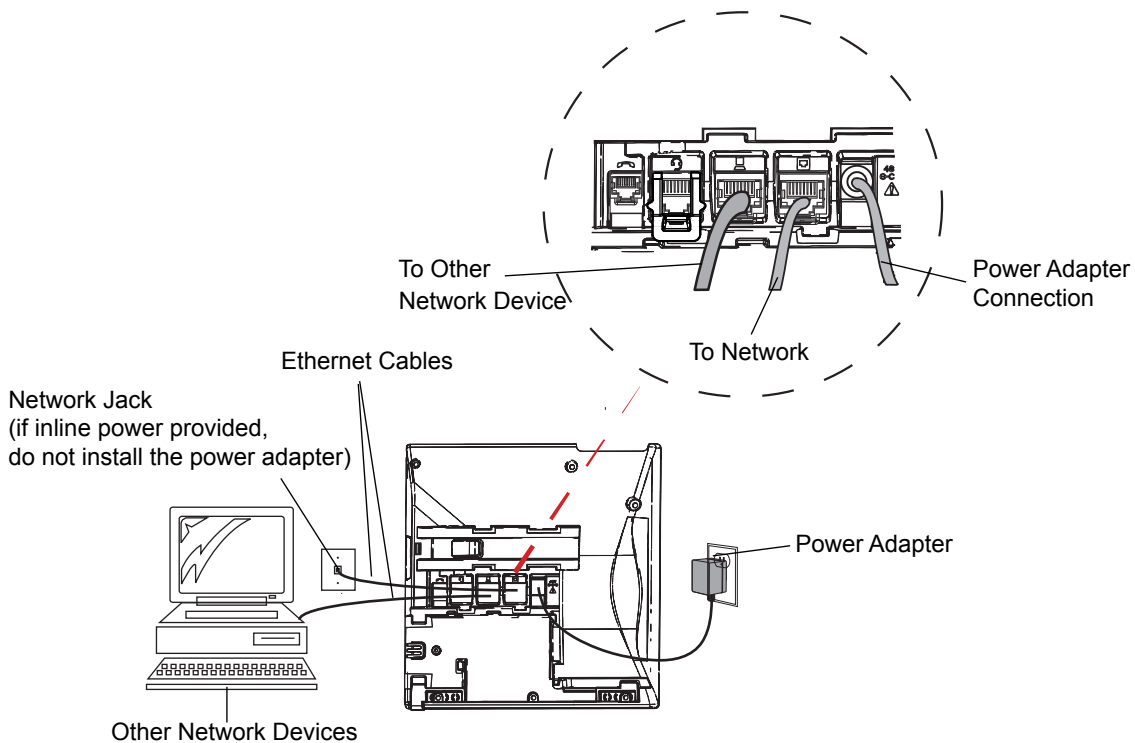

SHARED NETWORK CONNECTION

To connect a network device (such as a computer) to the phone, connect an Ethernet cable into the network port on the back of the phone marked with . Plug the other end of the Ethernet cable into the network jack on the network device for which you are sharing the network connection.



Notes:

1. The PC jack on the 6865i SIP Phone does not supply inline power onto other network devices.
2. All Ethernet cables used must be minimum Category 5/5e straight-through cables.

CONNECTING TO THE NETWORK AND TO POWER

POWER ADAPTER

Use the power adapter (sold separately) with your phone and plug your phone into a power source.



WARNING: FOR POWER, USE ONLY THE GLOBTEK INC. LPS ADAPTER MODEL NO. GT-41080-1848 (SOLD SEPARATELY) TO CONNECT FROM THE DC POWER PORT ON THE PHONE TO A POWER SOURCE.

INLINE POWER

If your network provides 802.3af compliant inline power, the phone is powered through the network.

- 1. On the back of your phone, connect an Ethernet cable into the network port marked with .
- 2. Plug the other end of the Ethernet cable directly into the network jack on the wall.

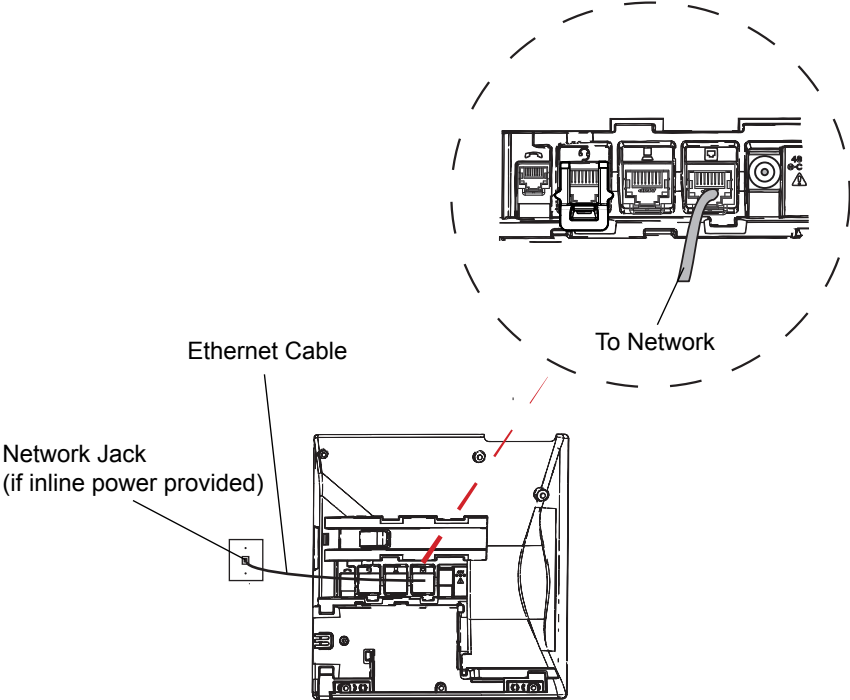

CONNECTING A HANDSET OR HEADSET

HANDSET

Turn the phone over and locate the handset jack marked . Insert one end of handset cord into the jack until it clicks into place. Then route the handset cord through the groove as shown in the illustration below. Attach the handset to the other end of the handset cord.

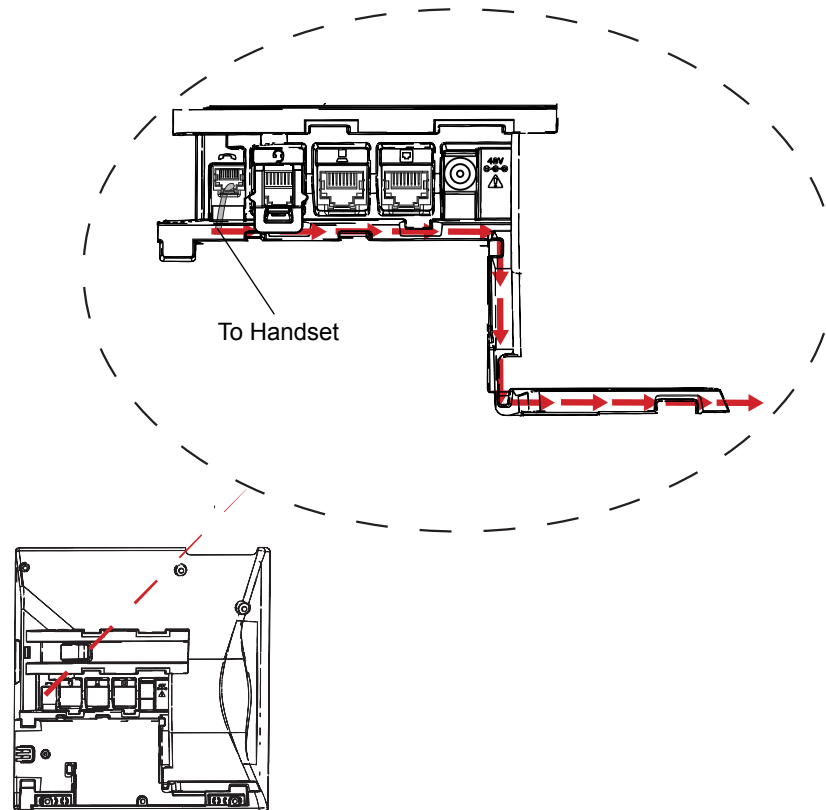

HEADSET (OPTIONAL)

Turn the phone over and locate the headset jack marked . If you have a headset with an RJ9/RJ22 4-pin connector, insert the headset cord into the jack until it clicks into place. Then route the headset cord through the groove as shown in the above illustration.

If you have a DHSG/EHS headset with an RJ45 6-pin or 8-pin connector, remove the plastic headset jack adapter and then insert the cord into the jack until it clicks into place.

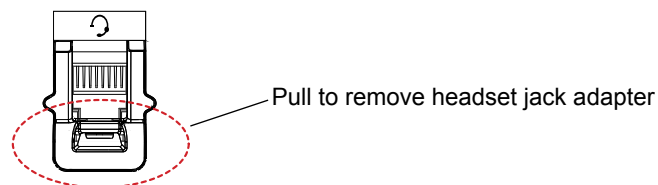

WARNING: THE HEADSET PORT IS FOR HEADSET USE ONLY. PLUGGING ANY OTHER DEVICES INTO THIS PORT MAY CAUSE DAMAGE TO THE PHONE AND WILL VOID YOUR WARRANTY.

INSTALLATION

DESK INSTALLATION

For desk installation of the 6865i IP Phone a reversible stand is included that attaches to the back of the phone above the various ports. Two viewing angles (30° low angle and 60° high angle) are available allowing users to personalize their phone viewing preference.

1. Locate the stand insertion area on the back of the phone (above the various ports).
2. Carefully insert the stand into the insertion area and slide the stand towards the right until it snaps in place.



Note: The orientation of the stand determines the viewing angle. If the bottom of the stand is installed facing the top of the phone the viewing angle will be 30°. If the bottom of the stand is installed facing the bottom of the phone the viewing angle will be 60°

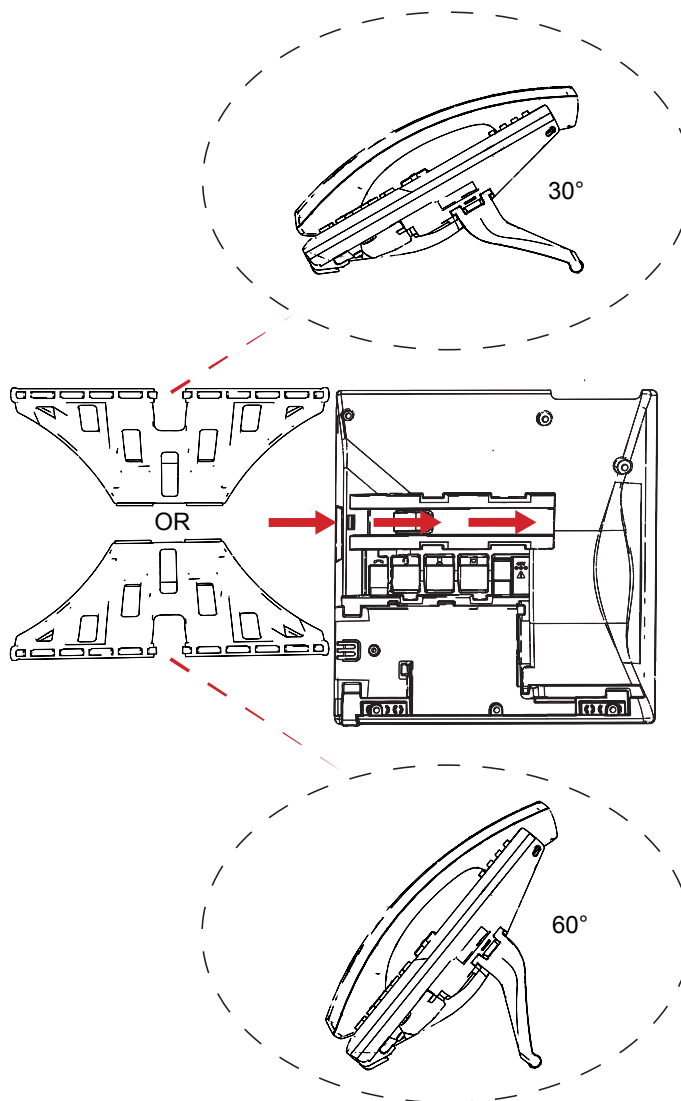

WALL INSTALLATION

The 6865i IP Phone can be mounted to a wall using the Mitel 6800i Series Wall Mount Kit (optional accessory). The 6800i Series Wall Mount Kit is designed to be used with all 6800i Series IP Phones allowing you to easily and securely mount your phone in one of two ways:

- Directly to the wall
- On top of an existing telco wall plate



Note: Refer to the *Mitel 6800i Series Wall Mount Kit Installation Guide* for additional product and installation details.

INSERTING THE KEY CARD

The key card contains label identification spaces for the 8 programmable keys.

1. Insert the paper key card into the programmable key card slot on the front panel of the telephone using the indentation of the plastic for alignment.

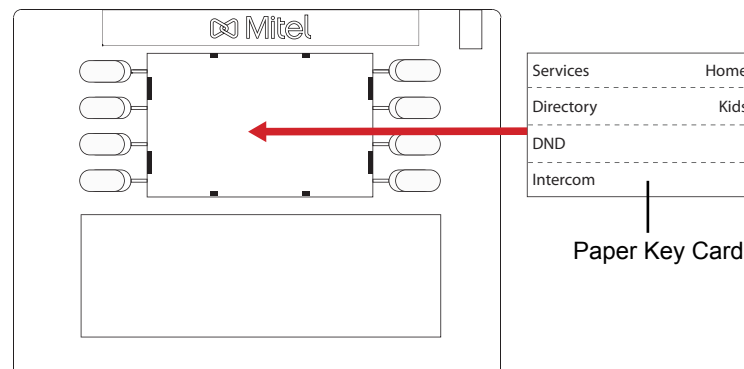

2. Place the plastic cover over the paper key card ensuring the plastic cover tabs are inserted into their respective slots.

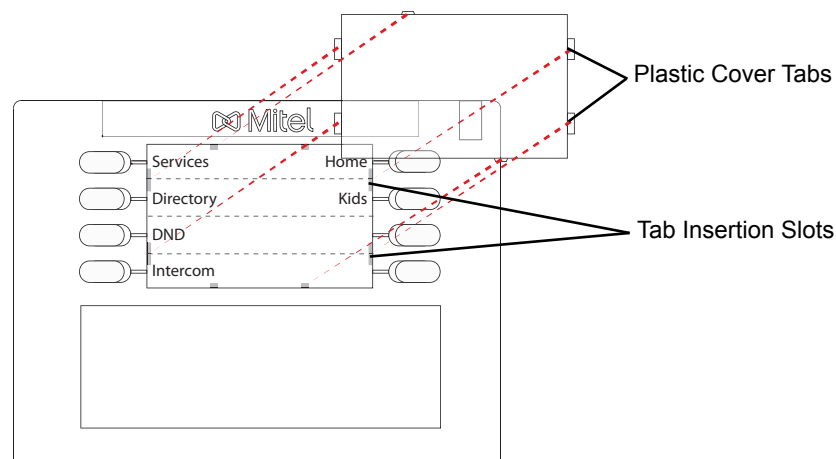

3. Press the plastic cover down firmly to even out and secure the plastic cover to the phone.

ACCESSING YOUR OPTIONS VIA THE PHONE UI

1. Press the **Options** key on the phone to enter the options list.
2. To navigate to an option, use the **UP** and **DOWN** navigation keys to scroll through the list.
3. Press the **RIGHT** navigation key, the **Select** key, or press the number of the corresponding option using the keypad to select an option.
4. Use the navigation keys to change and set various options.
5. Press the **LEFT** navigation key or the **Goodbye** key at any time to exit without saving changes.

ACCESSING YOUR OPTIONS VIA THE MITEL WEB UI

You can use the following procedure to access the phone options using the Mitel Web UI.

1. Open your web browser, enter the phone's IP address or host name into the address field and press **<Enter>**.

The following logon screen displays.



2. At the prompt, enter your username and password and click **OK**.



Note: For a user, the default user name is “user” and the password field is left blank.

The Network Status window displays for the IP Phone you are accessing.

System Information

Network Status

Attribute	LAN Port	PC Port
Link State	Up	Down
Negotiation	Auto	Auto
Speed	100Mbps	10Mbps
Duplex	Full	Half

Hardware Information

Attribute	Value
MAC Address	00-11-22-33-44-55
Platform	6865i Revision 0

Firmware Information

Attribute	Value
Firmware Version	4.0.0.10
Firmware Release Code	SIP
Boot Version	1.0.0.0
Date/Time	May 4 2013 03:27:15

SIP Status

Line	SIP Account	Status	Backup Registrar Used?
1	650@proxy.com:5060	Registered	Yes
2	651@proxy.com:5060	Registered	Yes
3	653@proxy.com:5060	Registered	Yes
4	654@proxy.com:5060	401	No

3. You can logout of the Mitel Web UI at any time by clicking **Log Off**.

The side menu options that display in the Network Status window are dependent on whether you log in as an Administrator or User. A longer list of options display in the side menu for an Administrator.

TROUBLESHOOTING SOLUTIONS

WHY IS THE LIGHT NOT COMING ON WITH A NEW VOICE MAIL MESSAGE?

Your phone system or service provider must provide “visual” message waiting service for this function to work. Check with your system administrator for more information.

WHY IS MY HANDSET NOT WORKING?

Check to ensure that the handset cord is fully connected to both the phone and handset. See the section “[Connecting a Handset or Headset](#)” on [page 10](#) for information.

WHY IS MY DISPLAY BLANK?

Ensure that power is being provided to your phone. If your network does not provide inline power over Ethernet, you can obtain a PoE inline power injector to provide power over Ethernet locally to your phone. See the section “[Connecting to the Network and to Power](#)” on [page 8](#) for details.

WHY DOES THE TELEPHONE WOBBLE?

Make sure the cords are routed properly through the back of the phone, as indicated in the section, “[Connecting a Handset or Headset](#)” on [page 10](#). Check that the stand has been properly inserted.

WHAT IS A PROGRAMMABLE KEY?

There are 8 top hard keys (programmable up to 8 functions), located at the top of the front panel. These are keys that you can set to perform specific functions and access enhanced services provided by third parties (for example, XML applications).

LIMITED WARRANTY

(Not applicable in Australia – see below for Limited Warranty in Australia)

Mitel warrants this product against defects and malfunctions in accordance with Mitel's authorized, written functional specification relating to such products during a one (1) year period from the date of original purchase ("Warranty Period"). If there is a defect or malfunction, Mitel shall, at its option, and as the exclusive remedy, either repair or replace the product at no charge, if returned within the Warranty Period. If replacement parts are used in making repairs, these parts may be refurbished, or may contain refurbished materials. If it is necessary to replace the product, it may be replaced with a refurbished product of the same design and color. If it should become necessary to repair or replace a defective or malfunctioning product under this warranty, the provisions of this warranty shall apply to the repaired or replaced product until the expiration of ninety (90) days from the date of pick up, or the date of shipment to you, of the repaired or replacement product, or until the end of the original Warranty Period, whichever is later. Proof of the original purchase date is to be provided with all products returned for warranty repairs.

EXCLUSIONS

Mitel does not warrant its products to be compatible with the equipment of any particular telephone company. This warranty does not extend to damage to products resulting from improper installation or operation, alteration, accident, neglect, abuse, misuse, fire or natural causes such as storms or floods, after the product is in your possession. Mitel will not accept liability for any damages and/or long distance charges, which result from unauthorized and/or unlawful use.

Mitel shall not be liable for any incidental or consequential damages, including, but not limited to, loss, damage or expense directly or indirectly arising from the customer's use of or inability to use this product, either separately or in combination with other equipment. This paragraph, however, shall not apply to consequential damages for injury to the person in the case of products used or bought for use primarily for personal, family or household purposes.

This warranty sets forth the entire liability and obligations of Mitel with respect to breach of warranty, and the warranties set forth or limited herein are the sole warranties and are in lieu of all other warranties, expressed or implied, including warranties or fitness for particular purpose and merchantability.

WARRANTY REPAIR SERVICES

Should the product fail during the Warranty Period;

- **In North America**, please call 1-800-574-1611 for further information.
- **Outside North America**, contact your sales representative for return instructions.

You will be responsible for shipping charges, if any. When you return this product for warranty service, you must present proof of purchase.

AFTER WARRANTY SERVICE

Mitel offers ongoing repair and support for this product. This service provides repair or replacement of your Mitel product, at Mitel's option, for a fixed charge. You are responsible for all shipping charges. For further information and shipping instructions:

- **In North America**, contact our service information number: 1-800-574-1611.
- **Outside North America**, contact your sales representative.



Note: Repairs to this product may be made only by the manufacturer and its authorized agents, or by others who are legally authorized. This restriction applies during and after the Warranty Period. Unauthorized repair will void the warranty.

LIMITED WARRANTY (AUSTRALIA ONLY)

The benefits under the Mitel Limited Warranty below are in addition to other rights and remedies to which you may be entitled under a law in relation to the products.

In addition to all rights and remedies to which you may be entitled under the *Competition and Consumer Act 2010* (Commonwealth) and any other relevant legislation, Mitel warrants this product against defects and malfunctions in accordance with Mitel's authorized, written functional specification relating to such products during a one (1) year period from the date of original purchase ("Warranty Period"). If there is a defect or malfunction, Mitel shall, at its option, and as the exclusive remedy under this limited warranty, either repair or replace the product at no charge, if returned within the Warranty Period.

REPAIR NOTICE

To the extent that the product contains user-generated data, you should be aware that repair of the goods may result in loss of the data. Goods presented for repair may be replaced by refurbished goods of the same type rather than being repaired. Refurbished parts may be used to repair the goods. If it is necessary to replace the product under this limited warranty, it may be replaced with a refurbished product of the same design and color.

If it should become necessary to repair or replace a defective or malfunctioning product under this warranty, the provisions of this warranty shall apply to the repaired or replaced product until the expiration of ninety (90) days from the date of pick up, or the date of shipment to you, of the repaired or replacement product, or until the end of the original Warranty Period, whichever is later. Proof of the original purchase date is to be provided with all products returned for warranty repairs.

EXCLUSIONS

Mitel does not warrant its products to be compatible with the equipment of any particular telephone company. This warranty does not extend to damage to products resulting from improper installation or operation, alteration, accident, neglect, abuse, misuse, fire or natural causes such as storms or floods, after the product is in your possession. Mitel will not accept liability for any damages and/or long distance charges, which result from unauthorized and/or unlawful use.

To the extent permitted by law, Mitel shall not be liable for any incidental damages, including, but not limited to, loss, damage or expense directly or indirectly arising from your use of or inability to use this product, either separately or in combination with other equipment. This paragraph, however, is not intended to have the effect of excluding, restricting or modifying the application of all or any of the provisions of Part 5-4 of Schedule 2 to the Competition and Consumer Act 2010 (**the ACL**), the exercise of a right conferred by such a provision or any liability of Mitel in relation to a failure to comply with a guarantee that applies under Division 1 of Part 3-2 of the ACL to a supply of goods or services.

This express warranty sets forth the entire liability and obligations of Mitel with respect to breach of this express warranty and is in lieu of all other express or implied warranties other than those conferred by a law whose application cannot be excluded, restricted or modified. Our goods come with guarantees that cannot be excluded under the Australian Consumer Law. You are entitled to a replacement or refund for a major failure and for compensation for any other reasonably foreseeable loss or damage. You are also entitled to have the goods repaired or replaced if the goods fail to be of acceptable quality and the failure does not amount to a major failure.

WARRANTY REPAIR SERVICES

Procedure: Should the product fail during the Warranty Period and you wish to make a claim under this express warranty, please contact the Mitel authorized reseller who sold you this product (details as per the invoice) and present proof of purchase. You will be responsible for shipping charges, if any.

Manufacturer: Mitel Networks Corporation
745 Springvale Road
Mulgrave VIC 3170
ABN 16 140 787 195
Phone: +61 3 8562 2700

Limitation of Liability for Products not of a kind ordinarily acquired for personal, domestic or household use or consumption (e.g. goods/services ordinarily supplied for business-use)

- 1.1** To the extent permitted by law and subject to clause 1.2 below, the liability of Mitel to you for any non-compliance with a statutory guarantee or loss or damage arising out of or in connection with the supply of goods or services (whether for tort (including negligence), statute, custom, law or on any other basis) is limited to:
- a.** in the case of services:
 - i.** the resupply of the services; or
 - ii.** the payment of the cost of resupply; and
 - b.** in the case of goods:
 - i.** the replacement of the goods or the supply of equivalent goods; or
 - ii.** the repair of the goods; or
 - iii.** the payment of the cost of replacing the goods or of acquiring equivalent goods; or
 - iv.** the payment of the cost of having the goods repaired.
- 1.2** Clause 1.1 is not intended to have the effect of excluding, restricting or modifying:
- a.** the application of all or any of the provisions of Part 5-4 of Schedule 2 to the Competition and Consumer Act 2010 (**the ACL**); or
 - b.** the exercise of a right conferred by such a provision; or
 - c.** any liability of Mitel in relation to a failure to comply with a guarantee that applies under Division 1 of Part 3-2 of the ACL to a supply of goods or services.

AFTER WARRANTY SERVICE

Mitel offers ongoing repair and support for this product. If you are not otherwise entitled to a remedy for a failure to comply with a guarantee that cannot be excluded under the Australian Consumer Law, this service provides repair or replacement of your Mitel product, at Mitel's option, for a fixed charge. You are responsible for all shipping charges. For further information and shipping instructions contact:

Mitel Networks Corporation
745 Springvale Road
Mulgrave VIC 3170
ABN 16 140 787 195
Phone: +61 3 8562 2700



Note: Repairs to this product may be made only by the manufacturer and its authorized agents, or by others who are legally authorized. Unauthorized repair will void this express warranty.

